

SeaLand® VACUUM TOILET OWNER'S MANUAL

VacuFlush® 140 Series Toilets

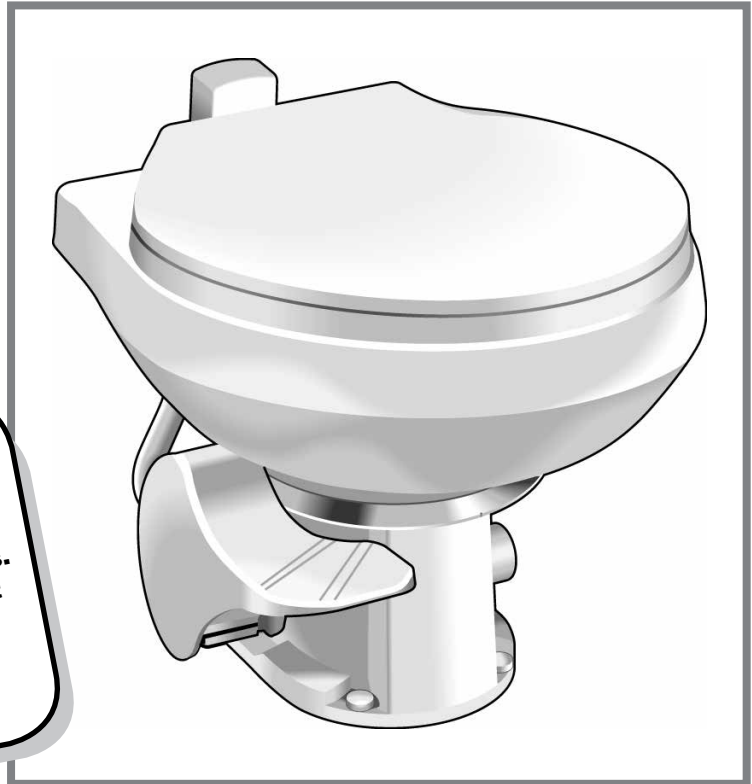

IMPORTANT NOTICE

VacuFlush® sanitation systems must be installed according to Dometic's recommended procedures. Do not attempt installation without first contacting a SeaLand Product certified dealer or Dometic Corporation.



WARNING

This manual must be read and understood before adjustment, maintenance, or service is performed. Modification of this product can result in property damage.

SeaLand®

by Dometic GROUP

Dometic Corporation, Sanitation Systems
13128 State Rt 226, PO Box 38, Big Prairie, OH 44611
SeaLand Product Hotline 1-800-321-9886
www.Dometic.com

TABLE OF CONTENTS

Product Features	2	Vacuum Tester	6
Key System Components	3	Service Tip	6
Toilet Model Identification	4	Convenience Products	7
Toilet Operation	4	Ordering Parts	7
Proper Cleaning	5	Toilet Dimensions	7
Winterizing	5	Troubleshooting Guide	8 - 10
Clearing Discharge Lines	5	Customer Service	11
Maintenance	6	One-Year Limited Warranty	12



WARNING – HIGH VOLTAGE SYSTEM.
Turn off electrical power before servicing.



WARNING – PUMP STARTS AUTOMATICALLY.
Turn off electrical power before servicing.

PRODUCT FEATURES

Dometic brings the technology, comfort and efficiency of SeaLand® toilet systems with VacuFlush® technology in an easy-to-use and easy-to-maintain package.

- **Freshwater Flush**
 - Eliminates the unpleasant sulfide odors which plague saltwater systems.
 - Eliminates the need to draw flush water through the through-hull, seacock and vented loop.
 - Significantly extends life of system components by eliminating salt water and impurities from accumulating in the system over time.
- **Efficient Design**
 - Consumes a little over a pint of water per flush and allows boat owners to use a small waste tank. The VacuFlush system fills a 10-gallon tank in the same time that an electric toilet fills a 40-gallon (113.6 liter) tank.
 - Uses only 4-6 amps per flush on 12VDC.
- **Delightful Operation**
 - Simple one-lever flush control. No complex instructions needed.
 - Comfortable adult-sized seat.
 - Large water surface maintains clean bowl.
 - Vitreous china bowl.
- **Reliability is Built-In**
 - USCG Certified Type III Marine Sanitation Device when installed with holding tank.
 - No impellers or macerators – vacuum pump motor can run dry without burning up. No dynamic seals.
 - Vacuum tank and vacuum generator design eliminates clogging problems associated with other systems.
- **Dispose of Sewage Conveniently and Safely**
 - Toilet can be used without discharging sewage into sensitive waters.
 - Holding tank discharge is at a dockside pump or at sea with optional overboard discharge.
 - No portable toilet tanks to haul or dump.
- **Backed by the Best in Service and Quality**
 - The VacuFlush system is from Dometic – the leader in marine sanitation.
 - Worldwide parts availability and technical support.

Dometic reserves the right to change specifications without notice.

KEY SYSTEM COMPONENTS

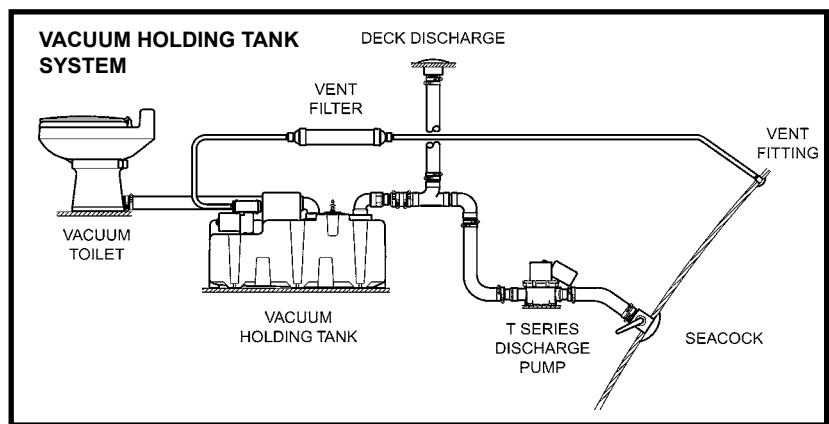
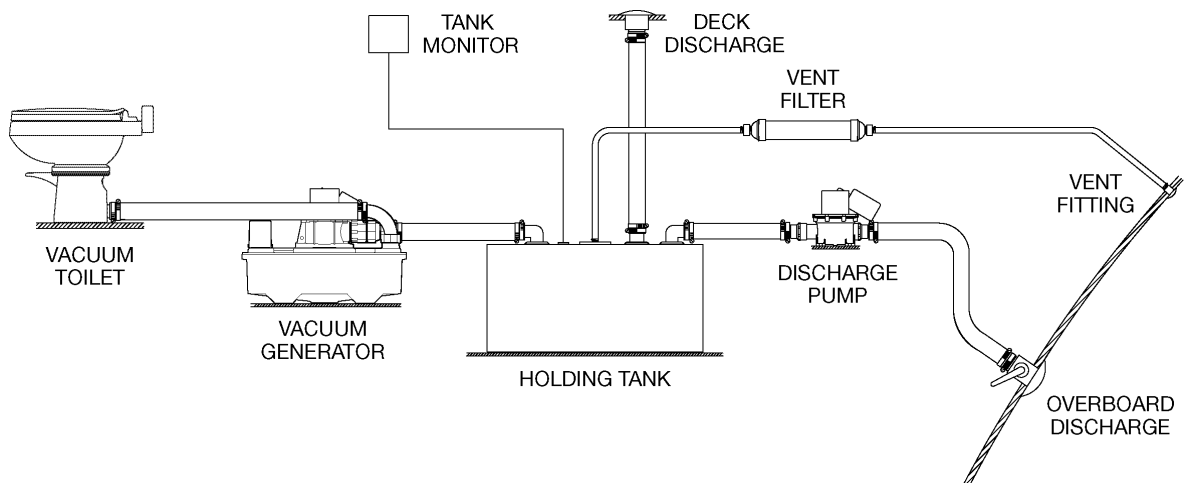

Vacuum Toilet: The VacuFlush toilet operates in a way different from other marine toilets. VacuFlush systems use a small amount of water (a little more than a pint) per flush in addition to a simple vacuum. The toilet is connected to a pressurized freshwater system. Fresh water is the key to an **odor-free bathroom compartment**. VacuFlush toilets are equipped with an integral vacuum breaker which prevents the possible contamination of the potable water supply.

Vacuum Generator: The vacuum generator combines a vacuum tank and vacuum pump in one unit. It greatly reduces installation time and eliminates the hose run between the tank and pump. Its compact size makes it especially well-suited to smaller crafts.

Vacuum Tank: The vacuum tank stores vacuum energy. System vacuum level is monitored by a vacuum switch located on the vacuum tank. When this switch senses a drop in vacuum in the system, it automatically signals the pump to energize and bring the vacuum to operating level. This process is normally completed in less than one minute. In a properly operating system, the stored vacuum will leak down between flushes, causing the vacuum pump to run for a short period.

Vacuum Pump: The vacuum pump is an electric, straight-through bellows type. It is manufactured of long-lasting polypropylene and draws only 4 to 6 amps of current at 12VDC. This unique pump design is both an efficient air and liquid pump, and handles solids without a problem. It has two duckbill valves on each side of the pump chamber.

Vacuum Holding Tank: A vacuum holding tank combines the vacuum tank, vacuum pump and holding tank. Refer to the Vacuum Holding Tank Owner's Manual (part no. 600343026) for installation and other information.

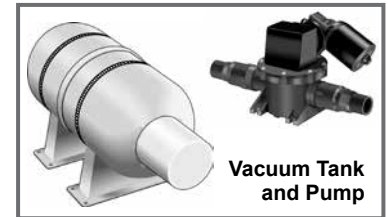
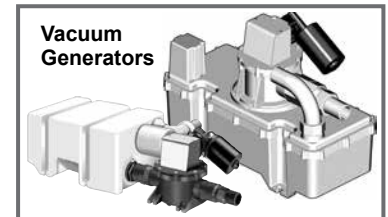

TOILET MODEL IDENTIFICATION

The toilet model identification label is located on the toilet base and will show the model number and serial number.



TOILET OPERATION

IMPORTANT INFORMATION BEFORE OPERATION

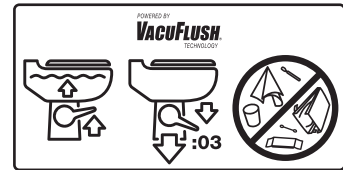

1. Fill freshwater tank and add deodorant to holding tank through toilet bowl. (See System Start-Up section.)
2. Make sure all guests understand the operation of the VacuFlush system and the instruction label is in plain sight and easy for guests to read. **If this label is not included in this manual, please contact the SeaLand Product Customer Service Department immediately.**
3. Remember the vacuum pump starts automatically. Shut off the system before servicing and do not leave the boat with toilet system breaker on.
4. **Never use drain openers, alcohol, solvents, etc. in the system.**
5. If the system does not function properly, refer to the Troubleshooting section of this manual and repair as necessary. If problem persists, contact your local SeaLand product dealer.



SYSTEM START-UP

1. Turn on electrical power to system.
2. Flush water into system by depressing flush lever until water starts flowing to the vacuum pump, about 15 seconds. This wets the pump interior for efficient operation. If vacuum pump does not run, check for loose electrical connections.
3. The vacuum pump will run for approximately 30 to 90 seconds until system reaches operating vacuum level and then will shut off.

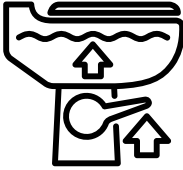
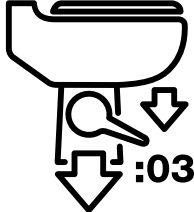
NORMAL OPERATION

<p>1. To add water to the toilet before using, raise flush lever until desired water level is reached. Generally, more water is required only when flushing solids.</p> 	<p>2. To flush toilet, press flush lever sharply down to the floor. A sharp popping noise is normal when the vacuum seal is broken. Hold lever down for three (3) seconds. After flushing, let flush lever snap back into original position. If flush lever is accidentally released before waste clears bowl, do not attempt to flush toilet again until vacuum pump stops running. A small amount of water should remain in the bowl after flushing.</p> 	<p>3. Do not dispose of sanitary napkins or other non-dissolving items in toilet, such as facial tissue or paper towels. These items can cause plugging of the system.</p> 
---	---	--

NOTE: Make sure all guests understand the operation of the SeaLand toilet, and that the instruction label is easy to read and in plain sight.

PROPER TOILET CLEANING

To maintain the toilet's original, lustrous appearance, use SeaLand® Toilet Bowl Cleaner or other non-abrasive bathroom and toilet bowl cleaners. Please follow label directions.



Caution

To avoid damaging the toilet system's seals and valves, do not clean toilet with abrasive cleaners, caustic chemicals, or lubricants and cleaners that contain alcohols or petroleum distillates.

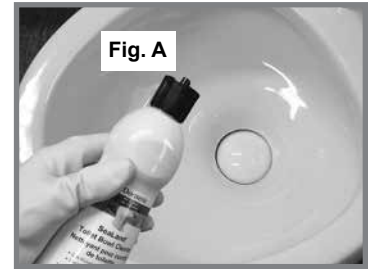

WINTERIZING

At the end of each season, the SeaLand toilet should be winterized for storage, by either draining or using potable water-safe antifreeze in the system.

To drain:

1. Thoroughly flush system with fresh water.
2. Empty holding tank.
3. Shut off water supply to toilet(s), and remove inlet waterline (Fig. B).
Do not remove cap on bottom of valve.
4. Press flush lever until all water is drained from toilet(s).

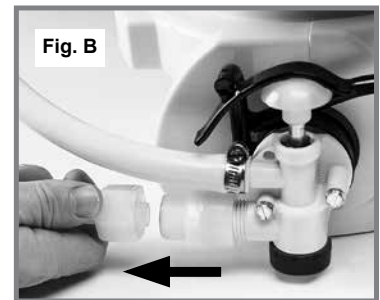

To use antifreeze:

1. Drain potable water tank.
2. Add freshwater antifreeze to potable water tank.
3. Flush potable water antifreeze and water mixture through toilet(s) and into the waste holding tank. Each installation is different, so amounts may vary. User discretion is required to assure adequate protection.
4. Empty holding tank.

NOTE: Use nontoxic antifreeze designated for potable water systems. (See vehicle owner's manual.)

CAUTION: Never use automotive-type antifreeze in freshwater systems.

CLEARING DISCHARGE LINES

Sanitation hoses should be cleared if toilet will not be needed for an extended period of time (more than two weeks).

1. Fill toilet bowl with water and add 4 oz. (120 ml) of biodegradable laundry detergent (should NOT contain bleach).
2. Flush toilet, holding pedal down for about two minutes. Close flush ball.
3. Turn off water supply to toilet.
4. Flush the toilet without water, allowing the vacuum pump to shut off after the flush. Repeat three times.
(This procedure will minimize any remaining water in the sanitation hoses.)
5. Turn off power to the vacuum pump.
6. Completely pump out holding tank.

If system will be subjected to freezing temperatures, please follow above procedure, then winterize system.

MAINTENANCE

Maintenance intervals and normal parts replacement vary widely depending on numerous factors such as: type of vessel, frequency of system use, quality of flushing water, etc. The chart below is intended strictly as a general guideline. Owner discretion and consideration of actual usage must be the first basis for determining proper maintenance levels.

Maintenance Procedure	Approximate Maintenance Level
Follow cleaning procedures above.	Monthly
Tighten all clamps, including base clamp ring.*	Annually
Check all wire connections.	Annually
Check & tighten water valve mounting screws.	Annually
Clean filter screen in water valve.	Annually
Check vacuum pump and in-line duckbill valves.	2-3 years or as needed
Check toilet seals.	3-5 years or as needed
Check vacuum breaker.	3-5 years or as needed
Check water valve.	3-5 years or as needed

*See Base Assembly - Page 8.

VACUUM TESTER

Dometic has developed a simple tool to assist in identifying the location of vacuum leaks. The vacuum tester consists of a vacuum gauge and a cone-shaped plug. Inserting the plug in the inlet of the vacuum tank or generator isolates the toilet from the system. In this way a troublesome leak can easily be located in either system.

Order only the Vacuum Tester (part number 318530002) or as part of the complete system VacuFlush® maintenance kit (part number 385310228).

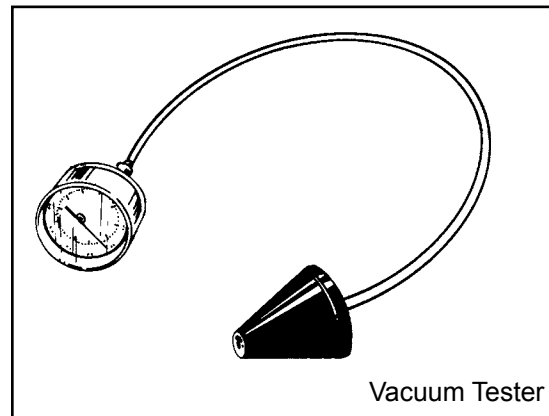

SERVICE TIP

Checking for leaks behind or under toilets or other appliances can make it difficult to locate the source. Dripping water at room temperature makes it difficult to feel wetness. Taking four or five sheets of toilet tissue and wiping all seams and waterline connections offers a simple means of locating the general area of the leakage. Start at the top of the unit since gravity will cause a leak to run downward. When the tissue comes in contact with the leaking water, it will immediately change texture.

CONVENIENCE PRODUCTS

Your marine dealer has SeaLand deodorants, tissue and other accessories on hand to make using and maintaining your VacuFlush toilet system as easy as possible.



SeaLand® Liquid Deodorant
Four 8-oz. bottles
Part No. 379700029



SeaLand® Cleaner
16-oz. bottle
Part No. 379314016



SeaLand® Clean 'n Green Bowl Cleaner & Tank Deodorant
12-2 oz. drop-in pouches
Part No. 379512602



SeaLand® Rapid-Dissolving Toilet Tissue
Four 500-sheet rolls
Part No. 379441204

ORDERING PARTS

Dometic is ready to assist you in the event service is required. Before calling, please have the following information available. Your cooperation in having this information ready is appreciated and allows our Customer Service Department to better meet your needs. When you call, we will direct you to the nearest stocking parts distributor.

1. Toilet Model Number
2. Serial Number
3. Part Number, Description and Quantity (See Parts List for information.)

TOILET DIMENSIONS

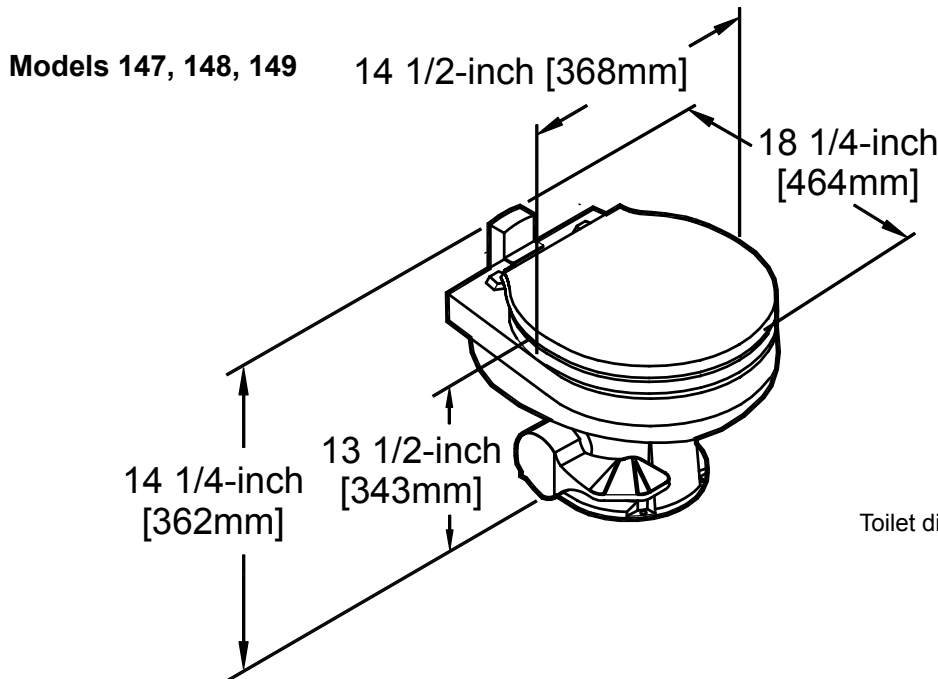

Toilet dimensions may vary ±3/8 inch (10 mm).

TROUBLESHOOTING GUIDE

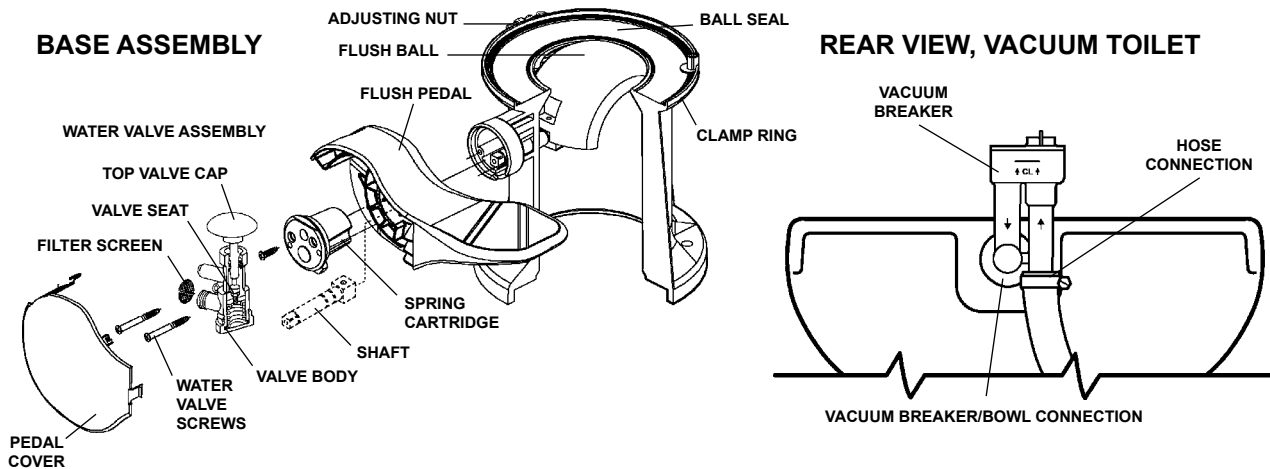

Problem	Possible Cause	Service Instructions
1. Water will not stay in bowl.	<ul style="list-style-type: none"> a. Loose clamp ring. b. Improper seal around flush ball due to dirt or debris on underside of ball seal. c. Worn or damaged seal. d. Worn or damaged flush ball. 	<ul style="list-style-type: none"> a. Tighten clamp ring adjusting nut. b. Inspect flush ball and underside of seal for foreign objects. Clean under seal if needed. c. Replace seal. d. Replace flush ball.
2. Plastic flush ball will not close completely.	<ul style="list-style-type: none"> a. Too much friction between flush ball and ball seal. b. Water valve screws are too tight. c. Defective spring cartridge. 	<ul style="list-style-type: none"> a. Lubricate between flush ball and ball seal with furniture polish or cooking spray. b. Loosen screws slightly. c. Check spring tension by pushing flush lever down, then release it suddenly. If lever does not snap back into original position, replace spring cartridge.
3. Flush ball will not open.	<ul style="list-style-type: none"> a. Broken shaft. b. Shaft not fully engaged in the spring cartridge. 	<ul style="list-style-type: none"> a. Replace shaft. b. Put pressure on shaft from under the flush ball (pushing into spring cartridge) until it engages. You may have to rotate flush ball slightly until shaft lines up with square in spring cartridge.
4. Water does not shut off in toilet (toilet overflows).	<ul style="list-style-type: none"> a. Dirt lodged in water valve seal. 	<ul style="list-style-type: none"> a. Disassemble and clean water valve.
5. Water does not enter toilet bowl properly.	<ul style="list-style-type: none"> a. Insufficient water flow rate at toilet. b. Water valve clogged. c. Plugged rim wash holes in toilet. 	<ul style="list-style-type: none"> a. Check water flow rate at toilet. Rate should be 2 gpm (7.6 lpm) at toilet. b. Remove and clean screen located at inlet of water valve. c. Clean holes. If still a problem, replace the toilet bowl.
6. Water leaking from water valve.	<ul style="list-style-type: none"> a. Water valve body cracked due to freeze damage. b. Water line connection is loose or not seated properly. c. Defective water valve. d. Stripped threads. 	<ul style="list-style-type: none"> a. Replace water valve. b. Insure that threads are not cross-threaded and tighten. c. Replace water valve. d. Replace water valve.

TROUBLESHOOTING GUIDE (cont'd)

Problem	Possible Cause	Service Instructions
7. Water leaking from rear of toilet bowl.	<ul style="list-style-type: none"> a. Worn or defective vacuum breaker. b. Loose vacuum breaker. c. Cracked or defective toilet bowl. 	<ul style="list-style-type: none"> a. Remove vacuum breaker cover and look into top of vacuum breaker. Flush toilet. If water leaks during flush, vacuum breaker needs to be replaced. b. Secure vacuum breaker connection. c. Replace toilet bowl.
8. Water is leaking from the base/toilet connection.	<ul style="list-style-type: none"> a. Clamp ring may be loose. b. Ball seals may be worn or defective. 	<ul style="list-style-type: none"> a. Remove plastic base cover (on applicable models) and tighten the clamp ring. b. Replace ball seals.
9. Vacuum pump running too often between flushes. (See Vacuum Tester Information on page 6.)	<ul style="list-style-type: none"> a. Water leaks out of bowl between flush ball and ball seal. b. Vacuum line leak. 	<ul style="list-style-type: none"> a. Leave small amount of water in bowl. If water is sucked from bowl, see problems 1 and 2. b. Tighten all connections at toilet, vacuum generator or vacuum holding tank (including hose clamps and threaded spin nuts). If leaks persists, contact SeaLand Product Customer Service.
10. Vacuum pump will not shut off.	<ul style="list-style-type: none"> a. A vacuum leak exists. b. Insufficient vacuum (pump creates less than 10 inches Hg). c. Faulty vacuum switch (pump creates more than 10 inches Hg). d. Improper wiring. e. Bellows not pumping. 	<ul style="list-style-type: none"> a. See problem 8b. b. Isolate pump and use vacuum gauge to check vacuum levels. Could be a plugged discharge line or worn duckbill valves. c. Replace vacuum switch. d. See wiring diagram to check for proper wiring. e. Tighten set screw in eccentric to motor shaft. Otherwise, check for damage to bellows and motor shaft. Replace if necessary.
11. Vacuum pump will not run.	<ul style="list-style-type: none"> a. No electrical power. b. Loose or broken electrical wiring. c. Improper electrical connections. d. Faulty vacuum switch. e. Faulty motor. f. Shut-down relay prevents pumping. 	<ul style="list-style-type: none"> a. Check input power, circuit breaker and fuse. b. Tighten or reconnect wires at vacuum pump and tank, vacuum generator, or vacuum holding tank. c. Be sure wires at vacuum switch are connected to "B" terminals. d. Check vacuum switch. Short across "B" terminals with jumper wire. e. Replace motor. f. Empty the holding tank.
12. Vacuum pump is running too slow, overheating, blowing fuses or circuit breaker.	<ul style="list-style-type: none"> a. Gear motor is worn or defective. b. Plugged vent line or vent filter. c. Blockage in discharge line. d. Improper wire size. e. Improper voltage. f. Vacuum pump bellows clogged with tissue. 	<ul style="list-style-type: none"> a. Check motor and replace if necessary. b. Disassemble and clean out vent line. Replace vent filter if necessary. c. Disassemble and clean discharge line. Be certain that in-line valves (duckbill valves) and seacock are in proper position. d. Wire size too small. Check electrical diagram for proper wire size for voltage of pump used. e. Check input power for low voltage. f. Remove and clean bellows assembly. (When flushing toilet, use of more water may alleviate this problem.)

TROUBLESHOOTING GUIDE (cont'd)

Problem	Possible Cause	Service Instructions
<p>13. Toilet will not flush. (No vacuum.) See problems 3 and 14 if necessary.</p>	<p>a. There is a blockage in the system.</p> <p>b. Pump will not run.</p> <p>c. Duckbill valves in vacuum pump are inverted due to blocked discharge line or an attempt to pump out against closed seacock.</p>	<p>a. Open flush ball and check the 1-inch (25mm) orifice at the bottom of the base for blockage and dislodge it. Never use drain-opening or other household plumbing chemicals. If blockage is not in base, it may be found in these locations:</p> <ul style="list-style-type: none"> • inlet of vacuum generator • diptube of vacuum generator • inlet of vacuum pump • outlet of vacuum tank <p>b. See problem 11.</p> <p>c. Replace duckbill valves, making sure they point in the correct direction.</p>
<p>14. Blockage between toilet and vacuum generator.</p>	<p>a. Collapsed vacuum line.</p> <p>b. Sharp bends or kinks in vacuum hose.</p> <p>c. Improper operation of toilet.</p> <p>d. Foreign objects were flushed down toilet.</p>	<p>a. Inspect vacuum line for collapsed condition and replace line if needed.</p> <p>b. Inspect vacuum hose for kinks or bends. If less than 8.5-inches (216mm) radius on any bend, reposition hose to achieve minimum 8.5-inch bend radius.</p> <p>c. Make sure each person using toilet knows correct procedure.</p> <p>d. DO NOT flush any non-dissolving items (i.e. sanitary napkins, facial tissue, wet strength tissue, paper towels, etc.) or excessive toilet tissue. Rapid-dissolving SeaLand brand toilet tissue is best.</p>
<p>15. Pump emits odor.</p>	<p>a. Loose or defective hose connection on pump.</p> <p>b. Loose intake or discharge fittings on pump.</p> <p>c. Worn, torn or punctured pump bellows (vacuum generator) or diaphragm (vacuum holding tank).</p>	<p>a. Tighten connections or replace hose and make new connections.</p> <p>b. Tighten intake or discharge fittings on pump. Replace nipples or adapters if necessary.</p> <p>c. Replace pump bellows or diaphragm.</p>

CUSTOMER SERVICE

A strong, worldwide network assists in servicing and maintaining your sanitation system. For the Authorized Service Center near you, please call from 8:00 a.m. to 5:00 p.m. (ET) Monday through Friday.

You may also contact or have your local dealer con-

tact the Parts Distributor nearest you for quick response to your replacement parts needs. They carry a complete inventory for the SeaLand product line.

Telephone: 1 800-321-9886 U.S.A. and Canada
330-439-5550 International

Fax: 330-496-3097 U.S.A. and Canada
330-439-5567 International

Website: <http://www.Dometic.com>
<http://www.DometicSanitation.com>

MANUFACTURER'S ONE-YEAR LIMITED WARRANTY

Dometic Corporation warrants, to the original purchaser only, that this product, if used for personal, family or household-like purposes, and if installed according to Dometic's recommended procedures, is free from defects in material and workmanship for a period of one (1) year from the date of purchase.

If this Dometic product is placed in commercial or business use, it will be warranted, to the original purchaser only, to be free of defects in material and workmanship for a period of ninety (90) days from the date of purchase.

Dometic reserves the right to replace or repair any part of this product that proves, upon inspection by Dometic, to be defective in material or workmanship. All labor and transportation costs or charges incidental to warranty service are to be borne by the purchaser-user.

EXCLUSIONS

IN NO EVENT SHALL **DOMETIC** BE LIABLE FOR INCIDENTAL OR CONSEQUENTIAL DAMAGES, FOR DAMAGES RESULTING FROM IMPROPER INSTALLATION, OR FOR DAMAGES CAUSED BY NEGLIGENCE, ABUSE, ALTERATION OR USE OF UNAUTHORIZED COMPONENTS. THIS INCLUDES FAILURES WHICH MAY RESULT FROM NOT FOLLOWING THE WINTERIZATION OR CLEANING PROCEDURES AS DESCRIBED IN THIS MANUAL. ALL IMPLIED WARRANTIES, INCLUDING ANY IMPLIED WARRANTY OF MERCHANTABILITY OR FITNESS FOR ANY PARTICULAR PURPOSE, ARE LIMITED TO A PERIOD OF ONE YEAR FROM DATE OF PURCHASE.

IMPLIED WARRANTIES

No person is authorized to change, add to, or create any warranty or obligation other than that set forth herein.

Implied warranties, including those of merchantability and fitness for a particular purpose, are limited to one (1) year from the date of purchase for products used for personal, family or household purposes, and ninety (90) days from the date of purchase for products placed in commercial or business use.

OTHER RIGHTS

Some states do not allow limitations on the duration of an implied warranty and some states do not allow exclusions or limitations regarding incidental or consequential damages; so, the above limitations may not apply to you. This warranty gives you specific legal rights, and you may have other rights which may vary from state to state.

To obtain warranty service, first contact your local dealer from whom you purchased this product.

Dometic Group is a customer-driven, world-leading provider of leisure products for the RV, automotive, truck and marine markets. We supply the industry and aftermarket with a complete range of air conditioners, refrigerators, awnings, cookers, sanitation systems, lighting, mobile power equipment, comfort and safety solutions, windows, doors and other equipment that make life more comfortable away from home.

Dometic Group supplies a wide range of workshop equipment for service and maintenance of built-in air conditioners. Dometic Group also provides specially designed refrigerators for hotel rooms, offices, wine storage and transport and storage of medical products.

Our products are sold in almost 100 countries and are produced mainly in wholly-owned production facilities around the world.

The logo for SeaLand, featuring the word "SeaLand" in a stylized, bold, italicized font with a registered trademark symbol.

by Dometic GROUP

Dometic Corporation
Sanitation Systems

13128 State Rt 226, Big Prairie, OH 44611
SeaLand Product Hotline 1-800-321-9886

www.Dometic.com
sealand@dometicusa.com